



EON[®]G2
G E N E R A T I O N 2

EON15 G2 User Guide



Contents



- Package Contents**4
- Agency Approvals and Certifications**4
- Before You Begin - Important Information**4
 - Mounting / Suspending EON Speakers4
 - Care and Maintenance4
 - Stand Mounting5
 - Electrical Safety5
- About the EON15 G2**5
 - Applications5
 - Features5
 - Specifications6
 - Frequency Response6
 - Available Accessories7
- Quickstart**7
- Controls and Connections**8
 - Connectors8
 - Switches8
 - Controls9
 - Indicators..... 10
- Voltage Selection And Fuses** 10
 - Changing Voltage 10
 - Fuse Replacement 10
- Application Examples** 11
 - Basic Sound Reinforcement System with Stage Monitors 11
 - Vocal / Acoustic-Electric Guitar12
 - Health Club Instruction 12
 - DJ or Sound Reinforcement System with EON PowerSubs13
 - DJ System with Passive Subwoofers14
 - Keyboard Amplification and Mixing 14
- Troubleshooting** 15-16
- Reference** 17
 - Connections - Balanced and Unbalanced17
 - Cables and Connectors 18
 - Loudspeaker Placement and Mounting19
- Block Diagram** 19
- JBL Limited Warranty and Contact Information**.....21

Welcome

Welcome to the family of discerning sound equipment users who have selected JBL Professional loudspeakers. EON is a creation of JBL, the world leader in sound reinforcement. JBL sound systems are used in some of the world's most famous arenas, concert halls and clubs. In fact, JBL speakers are the premier choice for today's hottest touring acts and artists. You just can't make a more professional choice. This User Guide contains important information that will help you get the most from your JBL EON loudspeakers so please take a moment to read it and be sure to keep it in a safe place for future reference.

Congratulations and thanks from all of us at JBL Professional. You have invested in the best portable performance system available.

PACKAGE CONTENTS

Your EON15 G2 system should include the following:

- 1 User Guide
- 1 EON15 G2 speaker
- 1 10' (3 m) IEC Power Cable

AGENCY APPROVALS AND CERTIFICATIONS

This EON G2 System complies with all International Safety Requirements for Mains Operated Professional audio equipment under IEC65, and Electromagnetic compatibility, Radio interference, Emissions and Immunity requirements.

BEFORE YOU BEGIN - IMPORTANT INFORMATION

Before using your EON15 G2 speaker system please review the following for important information on safety and protection of your investment in quality loudspeakers.

Mounting / Suspending EON Speakers

EON speakers are designed for portable applications in which the speakers will be stacked directly on the floor, stage, speaker stands, or a solid, stable platform. Optional accessory items are available from JBL Professional and after-market suppliers to facilitate suspension and wall/ceiling mounting of EON speakers. Only those items recommended by JBL Professional should be used. When using these items, review all enclosed documentation and carefully follow all instructions and safety precautions.

***CAUTION:** Suspension of speakers should be done by qualified persons following safe rigging standards and practices. Unsafe mounting or overhead suspension of any heavy load can result in serious injury and equipment damage.*

Care and Maintenance

While your EON speakers are rugged and will provide years of service, some common sense care in handling will prevent damage and preserve appearance.

- If your speakers will be frequently moved, consider a padded carrying bag (see AVAILABLE ACCESSORIES).
- If your EON speakers have been subjected to prolonged exposure to extreme low temperatures, avoid subjecting them to heavy mechanical shock and warm the speakers up by playing at a low volume for one hour before playing at loud levels.

- Keep the exterior of the speaker enclosure clean. Use a damp rag with a general-purpose household detergent. For grease and marking tape residue, use a damp cloth with isopropyl alcohol or mineral spirits and wipe dry. Do not use powerful solvents like acetone, MEK, lacquer thinner or 1,1,1-Trichloro-ethane (household cleaning fluid). These solvents will damage painted and co-polymer surfaces of your speakers.
- EON speakers are not intended for fixed installation in outdoor environments. Moisture can damage the speaker cone and surround, cause corrosion of electrical contacts, and create an electrical shock hazard. Protect your speakers from moisture. Avoid exposing the speakers to direct moisture. Any electrically powered device can produce dangerous shock hazards when wet or exposed to moisture. Keep speakers out of extended or intense direct sunlight. The driver suspension will prematurely dry out and finished surfaces will be degraded by long-term exposure to intense ultra-violet (UV) light.

Stand Mounting

Your EON speakers include a 35mm receptacle cup to facilitate mounting on tripod stands. When using stands, be sure to observe the following precautions:

- EON speakers include a thumb-screw that can be tightened to lock the speaker to the tripod stand. Before mounting the speaker on the stand, be sure to loosen the screw so that it doesn't prevent the pole from fully penetrating the socket.
- Check the stand specification to be certain it is designed to support the weight of the speaker (see specifications). Observe all safety precautions specified by the stand manufacturer.
- Always verify that the stand is placed on a flat, level, and stable surface.
- Route cables so that performers, production crew, and audience will not trip over them and pull the speaker over.
- Be sure to fully extend the legs of tripod type stands.
- Position the stand so that the legs do not present a trip hazard.
- Do not attempt to place more than one speaker on a stand designed for a single speaker.
- Always be cautious in windy, outdoor conditions. It may be necessary to place additional weight (i.e. sandbags) on the base of the stand to improve stability.

Electrical Safety

All EON products are fitted with a detachable power cord (supplied) which connects to the AC mains and the back panel of the loudspeaker. The power cord has an IEC female connector on one end and a male mains connector on the other end. This cord is supplied specifically to accommodate the different worldwide safety and electrical code requirements. The power cord supplied with your EON product has a 3-pin type plug. Do not cut off or damage the grounding plug. Like any electrical appliance, your EON powered speakers should not be used in water or when wet.

ABOUT THE EON15 G2

Applications

- Live sound reinforcement, speech and vocals, music playback in entertainment, A/V, and institutional venues - especially when ease of use and portability are important factors.
- Amplification, mixing, and monitoring for electronic musical instruments.

Features

- The second generation of one of the most successful and influential professional speaker systems ever.
- 15" Differential Drive® low-frequency driver with dual neodymium magnet for low-distortion and light weight.
- 1" throat diameter JBL compression driver with titanium diaphragm and ferro-fluid cooling.
- Bi-amplified 300 watts low-frequency and 90 watts high-frequency - **actual power delivered to the drivers.**
- Built in 3-input mixer. One balanced mic / line input, two balanced 1/4" phone line-level inputs. Two-band equalization.

- Balanced loop-through / mix output. "Daisy-chain" additional EON speakers or send the mixed output to a mixing console.
- 90° x 60° (nominal) constant directivity horn.
- Thermomaster® Total Thermal Management System®. A single piece, cast-aluminum baffle integrates the woofer frame, horn, and amplifier heat-sink. Air movement in the finned ports dissipates heat - no internal or external cooling fans are required.
- Rugged, light-weight, black co-polymer enclosure with cast aluminum baffle.
- Integral 35mm pole mount receptacle with securing thumb screw.
- Multi-angle enclosure for front of house or stage monitor application.
- Tailored dynamic processing protects amplifiers and speakers from being over-driven without producing extreme changes in frequency response as level varies.
- Extended low-frequency performance. Delivers powerful bass down to 39 Hz.

Specifications

| | | | |
|--------------------------|---|-------------------------|----------------|
| Freq. Range (-10 dB): | 39 Hz - 18 kHz | Freq. Response (±3 dB): | 42 Hz - 17 kHz |
| Horz. Coverage (-6 dB): | 90P nominal | Vert. Coverage (-6 dB): | 60P nominal |
| Rated Maximum SPL: | 129 dB, @ 1 m (3.3 ft) | | |
| Dimensions (H x W x D): | 686 mm x 430 mm x 444 mm (27 in x 17 in x 17.5 in.) | | |
| Net Weight: | 21 kg (46 lbs.) | | |
| LF Driver: | Integral frame with one 15" (380 mm) driver, dual neodymium magnet, 2" Differential-Drive® voice-coil. | | |
| HF Driver: | JBL2418H-1 1" (throat diameter) compression driver with 1.75" diameter titanium diaphragm. Ferro-fluid cooled. | | |
| Amplifier Power LF: | 300 watts @ low-frequency driver impedance. | | |
| Amplifier Power HF: | 100 watts @ high-frequency driver impedance. | | |
| Input 1 Sensitivity: | -44 dBu to -22 dBu for rated output (Mic/Line switch in MIC position) -12 dBu to +20 dBu for rated output (Mic/Line switch in LINE position) | | |
| Input 2 & 3 Sensitivity: | -18 dBu to +20 dBu for rated output | | |
| Output Level: | +20 dBu (peak), Loop/Mix switch in MIX position | | |

Audio Connectors

| | |
|-----------------|---|
| Input 1 | XLR/F, balanced |
| Input 2 & 3 | 1/4" Phone, balanced (TRS) |
| Crossover Freq. | 1.5 kHz |
| Limiting | Low frequency amplifier controlled by dynamic filter |
| Loop/Mix Out | XLR/M, balanced. |
| EQ: | High Frequency Shelving, ±15 Low Frequency Shelving, ±15 dB @ 120 Hz. |
| AC Input | 110 - 230 VAC, 50 - 60 Hz., 175 watts rating per UL, detachable IEC power cable |

Frequency Response

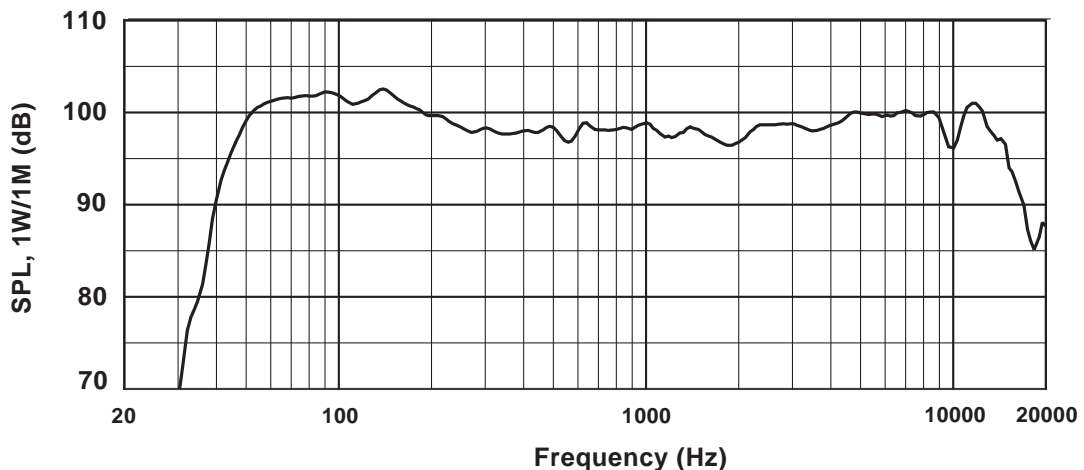

Available Accessories

| | |
|---------------|---|
| SS2-BK | Tripod Stand |
| ESK15 | Suspension Kit for EON 15" models |
| BRK15 | Bracket, adapts EON 15" models to OmniMount® brackets |
| EON15 BAG/W-1 | Zippered, plush-lined speaker bag with wheels |
| EON15 BAG-1 | Zippered, plush-lined speaker bag |
| EON BRK1 | Mounting bracket for EON 15" speakers - fixed angle |

QUICKSTART

1. Refer to the "Basic Sound Reinforcement System with Stage Monitors" diagram on page 10.
2. Turn the INPUT 1, 2, and 3 controls fully counter-clockwise.
3. Set the MIC/LINE switch.
 - If a microphone will be connected directly to INPUT 1, set the MIC/LINE switch to the MIC position (depressed). The MIC LED will illuminate when power is turned on.
 - If a mixer, CD player, cassette tape, or electronic musical instrument (the "source") will be connected directly to INPUT 1, set the MIC/LINE switch to the LINE position (disengaged). The MIC LED will not illuminate when power is turned on.
4. Set the EQ HF and LF controls to their center detented position.
5. Plug the power cable into a properly grounded 3-wire AC power.
6. Plug the XLR cable from the mixer or microphone into the INPUT 1 connector.
7. Connect other sources (if used) to the LINE 2 and LINE 3 input connectors.
8. POWER UP PROCEDURE
 - First, switch on the power to the mixer, audio sources, or musical instruments that are feeding your EON15 G2.
 - Next, turn on the power switch (the front panel power indicator will illuminate).
 - Reverse this process when shutting down your system.
9. SET VOLUME
 - If you are using an audio mixing console, refer to the manufacturer's instructions to properly set gain structure.
 - Turn up your sources to the level that will be used in performance and talk, sing or play into the system.
 - Bring the INPUT 1 control up (clockwise) until the desired volume has been reached. If you are using a microphone, turn the INPUT 1 control up slowly to avoid feedback.
 - If you are using the INPUT 2 and INPUT 3 inputs, bring the INPUT 2 and INPUT 3 controls up until the desired volume has been reached.
10. CHECK THE PEAK LED - The PEAK indicator flashes when the loudspeaker's on-board amplifiers are approaching maximum output. Occasional flashes are normal for very loud operation. However, if the PEAK LED stays illuminated, the sound may be distorted and it is an indication that more speakers or a lower performance volume may be required for your specific application.

CONTROLS AND CONNECTIONS

The audio section of the EON15 G2 includes powerful features that enhance the flexibility of your EON15 G2 speakers.

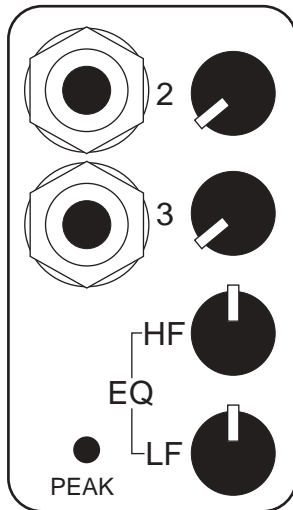
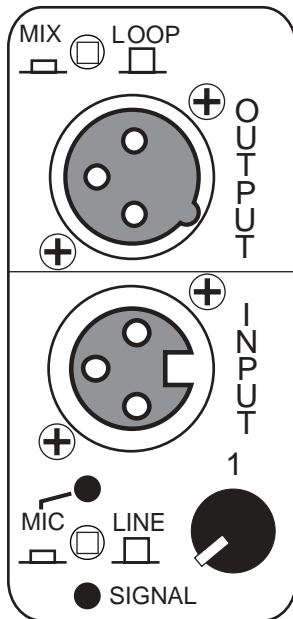

Connectors

INPUT 1

This balanced input accepts a standard XLR (female) connector. A broad range of signals (-44 dBu to +20 dBu nominal) from microphones, audio mixing consoles, and electronic musical instruments may be connected here. When using a single audio input to the speaker, this is the input to use. The sensitivity of this input is controlled by the MIC/LINE SWITCH and the INPUT 1 rotary control.

INPUT 2 & INPUT 3

These 1/4" phone jacks are intended for use with audio devices including cassette tape, CD, MP3 players, computer sound-card outputs, electronic keyboards, and electric/acoustic musical instruments. INPUTS 2 and 3 are balanced (TRS) but will accept unbalanced inputs with no special adapters needed. The level of these inputs is controlled by the INPUT 2 and INPUT 3 rotary controls.

OUT

This XLR (male) output connector works with the MIX/LOOP SWITCH to provide a method of sending audio from your EON15 G2.

Switches

MIC/LINE

The MIC/LINE switch effects only INPUT 1. It selects between two sensitivity ranges. This switch is used to match the input sensitivity of the EON15 G2 with the output level of the device connected to INPUT 1. Depressing the MIC/LINE switch selects MIC (most sensitive).

CAUTION: Before adjusting this switch, be certain to rotate the INPUT 1 control fully counter-clockwise. After the MIC/LINE switch has been adjusted, slowly rotate the INPUT 1 control clock-wise until the desired volume has been reached.

- Use the MIC position (depressed) when a microphone is connected to INPUT 1.
- Use the LINE position (disengaged) when a line level source such as an audio mixing console, audio playback device, or electronic musical instrument is connected to INPUT 1.

MIX/LOOP

This switch selects the source of the signal for the OUT connector.

CAUTION: Before adjusting this switch, be certain to set the input level control of any equipment connected to this output to its minimum gain (least sensitive) setting.

- In the disengaged position, only the signal from the INPUT 1 connector is routed directly to the OUT connector. Changing the other settings on the audio panel will not effect the OUT signal. The INPUT 2 and INPUT 3 inputs will not be present at the OUT connector. Use this setting when you want to feed multiple EON powered speakers the same signal.

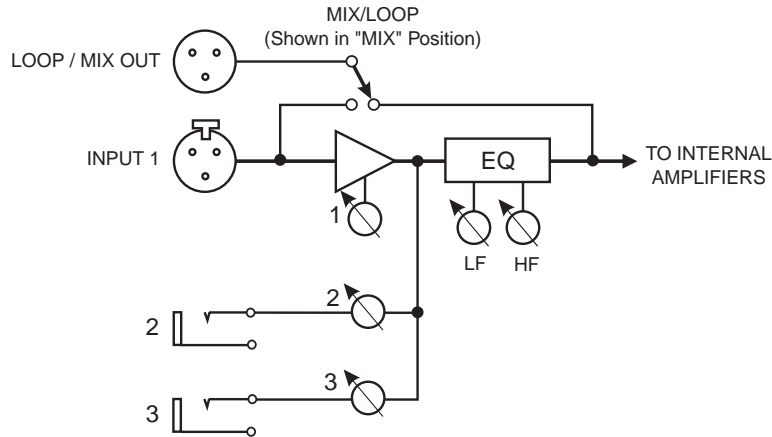

- In the MIX position (depressed), a post-EQ blend of all inputs to the speaker (INPUT 1, 2, and 3) will be sent to the OUT connector. Any changes to input level settings or EQ will affect the OUT signal. See the SYSTEM EXAMPLES section for details on how this mode may be used.

Controls

INPUT 1

Adjusts the level of INPUT 1. Use this control to match the input sensitivity of the EON15 G2 to the output level of the mixer, microphone, or instrument connected to INPUT 1. It is a common misconception that this control changes the power of a system. Your EON15 G2 will produce its rated output power no matter where this control is set. The INPUT 1 control determines how much signal is required at the input in order to drive the system to full output.

INPUT 2 & INPUT 3

These controls adjust the level of the inputs connected to INPUTS 2 and 3.

LF EQ

This control allows up to 15 dB of cut or boost at 120 Hz. If the system seems too “boomy” or bass heavy, rotate this control counter clock-wise. If the system sounds too “thin” or lacks low-end power, rotate this control clock-wise. To set the low-frequency EQ to “flat” (no EQ cut or boost), set this control to the center detented position.

HF EQ

This control allows up to 15 dB of cut or boost at 5k Hz. If the system seems too “strident” or “tinny”, rotate this control counter clock-wise. If the system sounds too “dark” or lacks “brilliance”, rotate this control clock-wise. To set the high-frequency EQ to “flat” (no EQ cut or boost), set this control to the center detented position.

Indicators

PEAK

The PEAK LED (Light Emitting Diode) illuminates to indicate that the system is approaching clipping. The threshold for this light is actually about 2 dB below clipping. An occasional flickering of this light on the loudest peaks is acceptable. If this LED is on for more than the duration of brief dynamic peaks, the system is being overdriven. Continuously over-driving the system will result in unpleasant and fatiguing distortion and may lead to premature failure of your speaker system.

If the PEAK LED illuminates excessively:

- Reduce INPUT 1, 2, and 3.
- Reduce the output level of the mixer, musical instrument, or other source connected to the speaker.
- If there is a great deal of LF EQ or HF EQ boost, return the controls to the "flat" (centered) position.

SIGNAL

Illuminates to indicate a usable signal from INPUT 1.

MIC

This LED lights to indicate that the MIC/LINE switch is in the MIC (depressed) position.

VOLTAGE SELECTION AND FUSES

Changing Voltage

Your EON15-G2 will typically be set at the factory to accommodate the power mains voltage in your area. Before you set up your EON15-G2 for the first time it is a good idea to verify that the setting of the selector is appropriate for the power in your area. In the event that you do need to change the voltage:

- Make sure that the speaker is powered off and the AC is disconnected from the speaker.
- Directly below the male IEC connector on the speaker is a voltage selector. Break the factory-applied seal and slide the switch to the appropriate setting.
- Set the voltage selector switch to the 115V or 230V setting as required for your area.
- After having reconfirmed that the correct voltage is selected, reconnect the AC (IEC connector) and power the unit up.

DO NOT UNDER ANY CIRCUMSTANCES OPERATE THE UNIT WITH THE WRONG VOLTAGE SELECTED. DOING SO MAY RESULT IN SERIOUS DAMAGE TO YOUR SPEAKER SYSTEM WHICH WILL NOT BE COVERED BY WARRANTY.

Fuse Replacement

The EON15 G2 has no user-serviceable fuses. Failure of fuses is most frequently a symptom of problems requiring service by a competent technician.

APPLICATION EXAMPLES

Basic Sound Reinforcement System with Stage Monitors

This is the basic live sound system. The optional tripod stands will get the speakers up above the audience so the sound can project. The second pair of EON15P G2 speakers are used as stage monitors. For maximum gain before feedback, position the monitors so that they do not point into microphones.

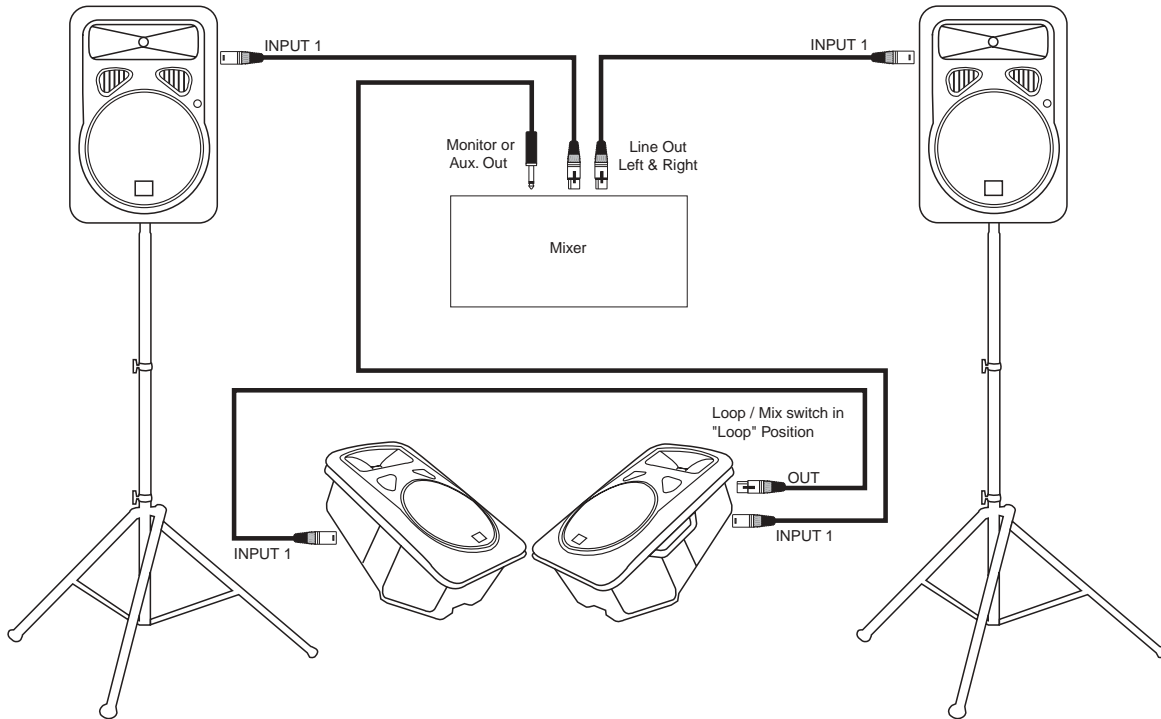

The output connectors on your mixer may differ from the illustration.

Vocal / Acoustic-Electric Guitar

Here's a simple set-up for a musician using an acoustic-electric guitar with a stereo pick-up and backing tracks to accompany live vocal performance. If stereo is not a requirement, simply omit the 2nd speaker

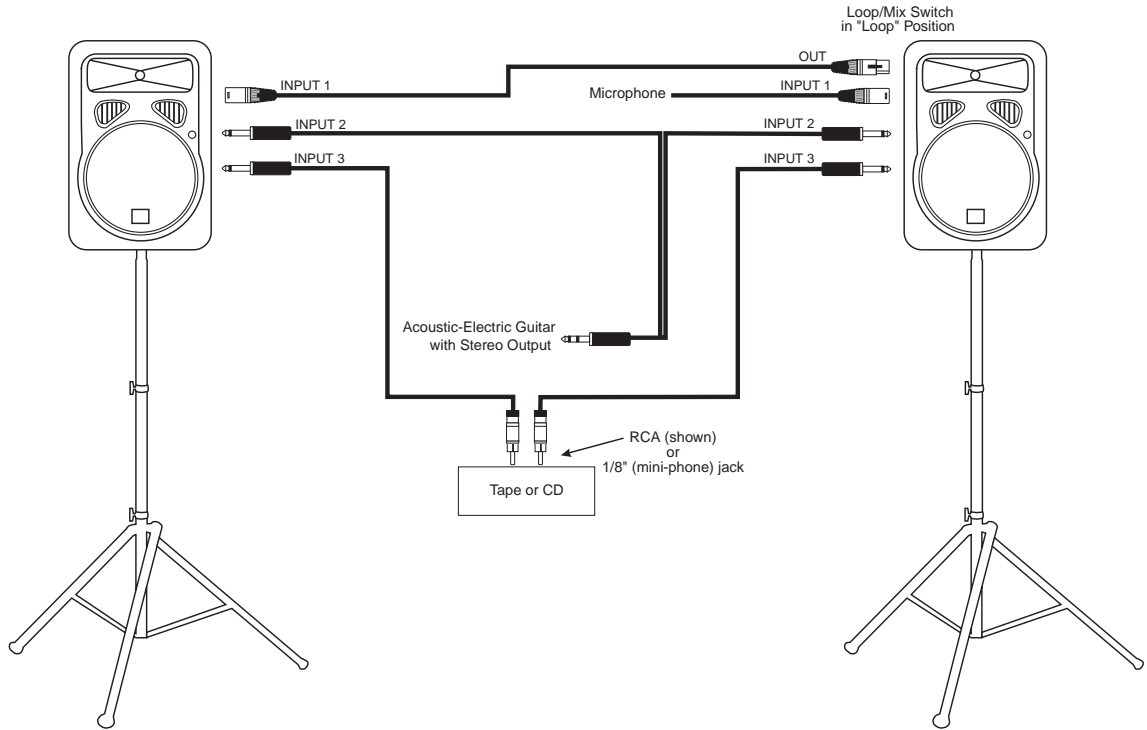

Health Club Instruction

For a simple to use system just add a headset style microphone for the instructor and a portable CD player. Refer to the previous "Vocal/Acoustic-Electric Guitar" diagram and omit the guitar.

DJ or Sound Reinforcement System with EON PowerSubs

Here's a system with EON PowerSubs added to provide additional low-frequency power. If your mixer has a SUM or MONO output, you can also drive the EON Powersubs from this output and use the volume control for the mono for bass mix effects.

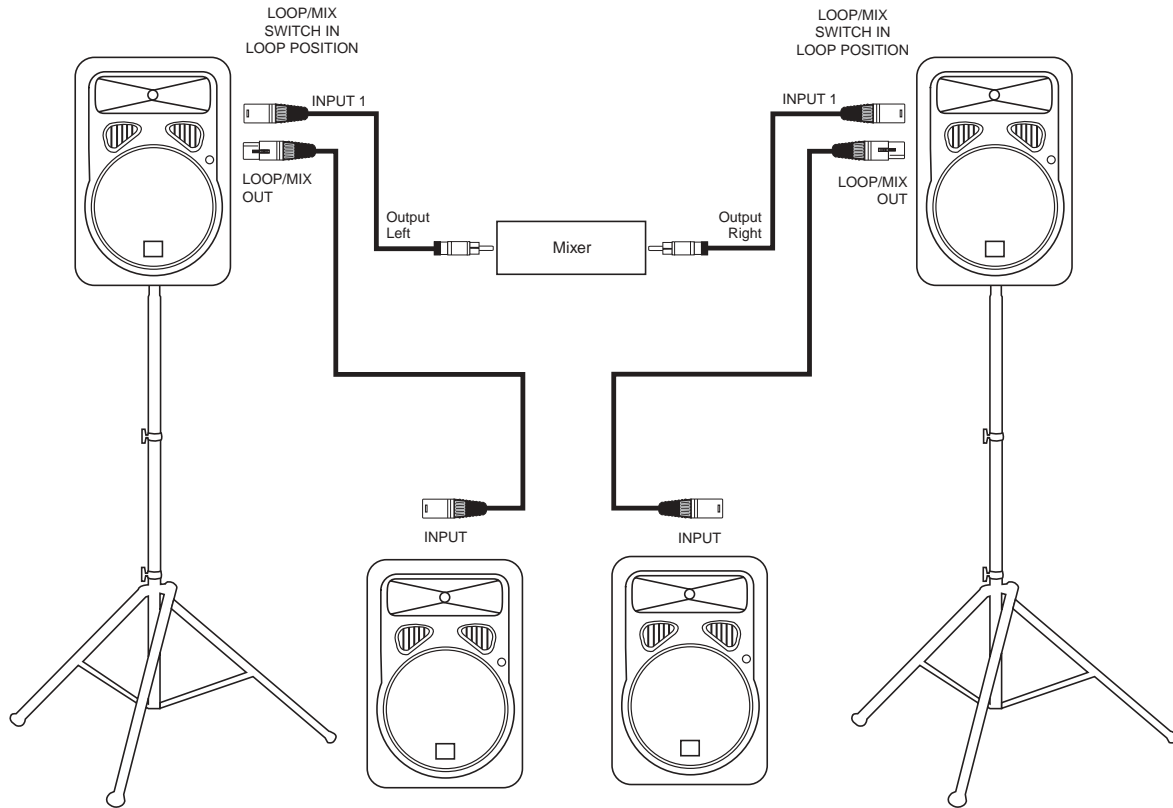

DJ System with Passive Subwoofers

This system combines a pair of EON15 G2 powered speakers with externally powered subwoofers for extra power at very low frequencies. Note that many, but not all DJ mixers use RCA (phono) outputs as illustrated. Your DJ mixer may use another type of connector.

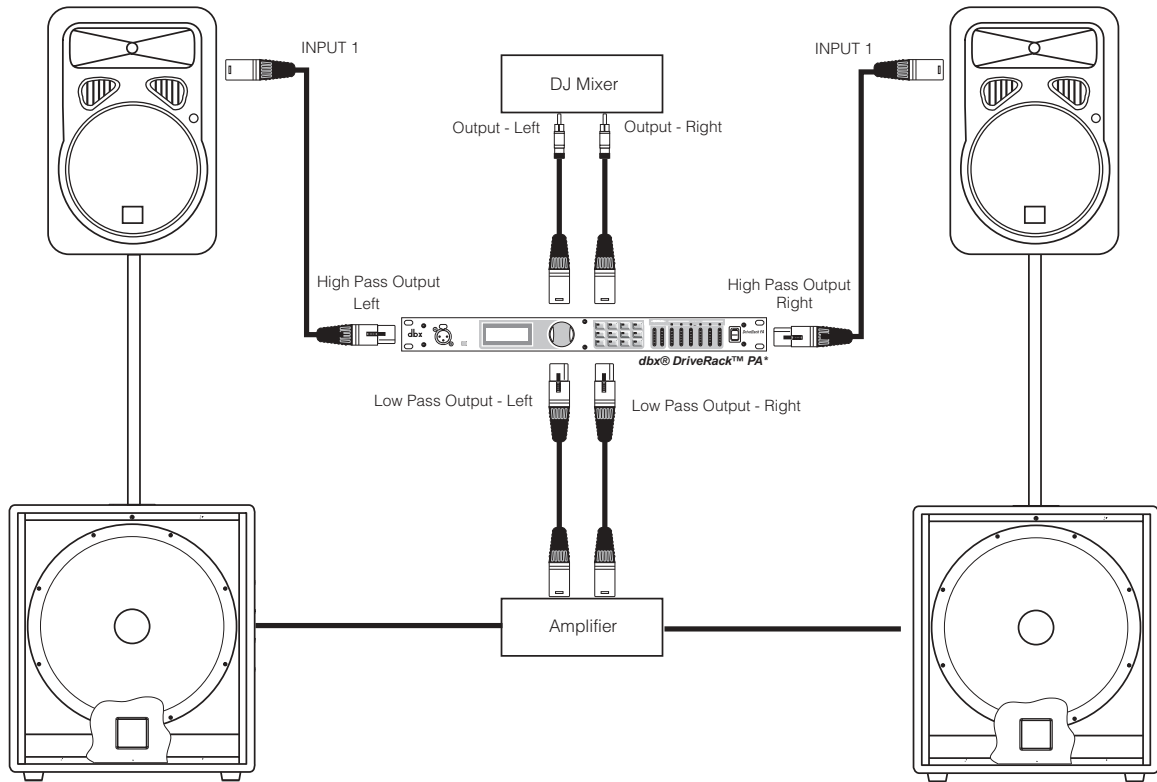

* Recommended crossover frequency = 80-150 Hz. (season to taste)

Keyboard Amplification and Mixing

In this set-up, the 3-channel mixer of the EON15 G2 combines the outputs from a digital piano, a synthesizer and a sampler. The "LOOP / MIX" switch is set to the "MIX" position and the "OUT" connector sends the combined signal to the main mixing console.

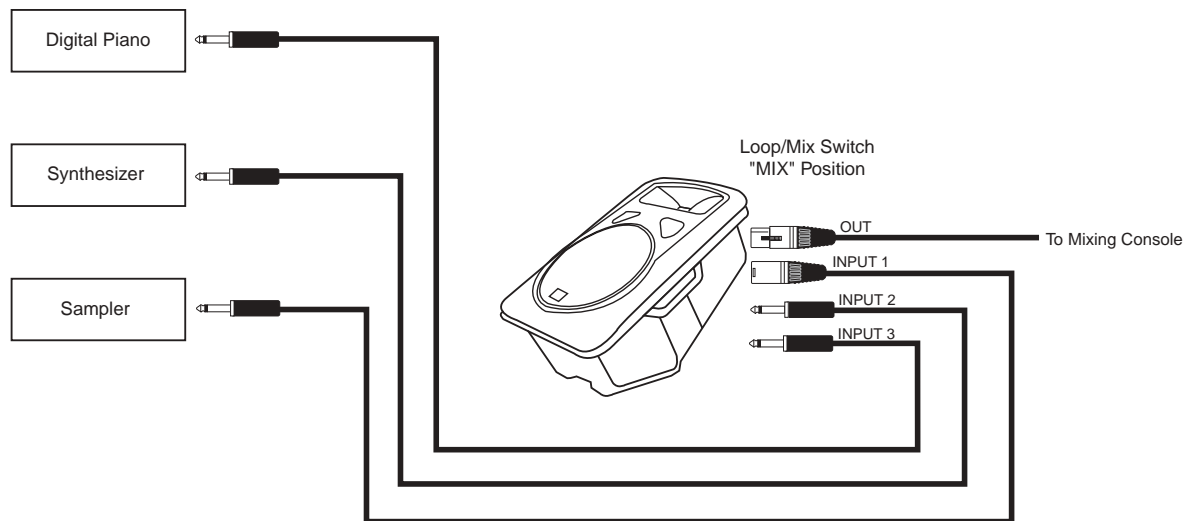

TROUBLESHOOTING

| Symptom | Likely Cause | What to do |
|--|---|--|
| No sound | Speaker not connected to active AC power | Verify that speaker is connected and that the circuit is on |
| | Power not switched on | Switch on power and verify that power LED is on |
| No sound, speaker is connected to working AC power but won't come on. | Speaker power cable is faulty or improperly connected. | <ul style="list-style-type: none"> • Re-seat the power cable at both ends. • Substitute a known-good power cable |
| | Blown fuse | <ul style="list-style-type: none"> • There are no user-serviceable fuses in the EON15 G2. Take your speaker to a competent servicer. |
| No sound. Speaker comes on. | Signal source (mixer, instrument, etc.) is not sending. | <ul style="list-style-type: none"> • Check VU meters on the source mixer • Verify that the tape or CD is playing. • Use headphones to verify that the instrument is actually sending an audio signal |
| | Faulty cables and connections | <ul style="list-style-type: none"> • Disconnect and re-seat signal cables. • Replace suspected cable with a known-good cable |
| No sound with microphone connected directly to the MIC/ LINE 1 input. | Microphone requires phantom power | The EON15 G2 does not supply phantom power. Switch to a dynamic microphone, use a battery in the microphone (if possible), use an external phantom power supply. |
| Signal sounds distorted and very loud, PEAK light is lit most of the time. | Excessive input signal, trying to exceed the capabilities of the speakers | <ul style="list-style-type: none"> • Reduce the output level of the source. • Turn down the level controls on the speaker. • Use additional EON speakers. |
| Signal sounds distorted even at moderate volumes, PEAK light is not lit. | Mixer or other source is overdriven | <p>Review the Owner's Manual for your mixer and adjust controls as needed.</p> <ul style="list-style-type: none"> • Input sensitivity (gain) • Channel faders • Master faders <p>Once this is done, review the instructions in the Quick Start section of this guide.</p> |
| Lots of hiss in the sound, the mixer controls are at very low settings. | Improper gain structure | <ul style="list-style-type: none"> • Make sure that the MIC/LINE switch is in the LINE (disengaged) position. • Reduce the level settings at speaker. <p>Review the Owner's Manual for your mixer and adjust controls as needed.</p> <ul style="list-style-type: none"> • Input sensitivity (gain) • Channel faders • Master faders |

| | | |
|--|--|--|
| Noise or hiss heard at output | Noisy source device | Disconnect the devices that are connected to your speaker one at a time. If the noise goes away, the problem is with the source or the connecting cable. |
| Hum or Buzz that increases or decreases when the mixer level controls are moved. | Improper A/C ground or faulty equipment connected to mixer input | Disconnect or mute channels one at a time to isolate the problem. Refer to the owner's manual of the faulty equipment for troubleshooting help. |
| | Faulty cable between source equipment and mixer | Substitute a known-good cable for the suspected faulty cable. |
| Hum or Buzz | Improper A/C grounding, ground loops | <ul style="list-style-type: none"> • "Telescope" the audio ground by using an XLR/F to XLR/M adapter on one end. • Re-route audio cables away from AC power and lighting cables. |
| | Excessively long unbalanced cable run | <ul style="list-style-type: none"> • Use the balanced outputs (if available) of your mixer or source equipment to drive your EON speakers. • Use a "DI" (direct injection) box to convert your unbalanced equipment output to a balanced output. |
| | Improper system gain structure | Reduce the INPUT 1, 2 and 3 controls and increase the output level of your source devices. |
| The inputs from INPUT 2 and INPUT 3 aren't coming out of the OUT connector | MIX/LOOP SWITCH set improperly | Set the MIX/LOOP SWITCH to the MIX OUT position (depressed). See the CAUTION in the "Switches" section of this manual. |
| The speaker connected to the OUT connector goes up in volume when I adjust the INPUT 1 control on the first speaker. | MIX/LOOP SWITCH set improperly | Disengage the MIX OUT switch. See the CAUTION in the down in "Switches" section of this manual. |
| Speakers feed back and howl when the microphone volume is turned up | Microphones are pointed into the speakers | Move the speakers so they do not point the microphone's pickup pattern. |
| | Equalizer settings are incorrect | Locate the feedback frequency and reduce it using the mixer EQ or an external equalizer. |
| | Excessive gain | Reduce the gain at the mixer and move the microphone closer to the sound source. |

REFERENCE

Connections - Balanced and Unbalanced

There are two basic types of audio system interconnections for audio signals: Balanced and Unbalanced. Your EON15 G2 can accept either type of input.

Balanced Lines

In audio, a balanced line is a three-conductor system in which the two signal wires carry an equal, but opposite voltage with respect to the ground wire. The ground wire acts only as a shield and does not carry any audio signal current. Outside interference (such as RFI - Radio Frequency Interference) is either shielded from the internal signal conductor, or if it gets into the cable is cancelled out by the opposite signals at the receiving end. Balanced connections are preferred for any longer cable runs.

Unbalanced Lines

Unbalanced cable is a two-wire system where the shield (ground wire) acts as one of the current carrying signal conductors. The center conductor enclosed by the shield is commonly known as the "hot" conductor. Unbalanced audio cables do not reject noise as well as balanced lines. Unbalanced lines are typical in home hi-fi type systems and on the outputs of electronic musical instruments. These work well if the distance between the components is short, the signal level is relatively high and all of the electronics used in the system are plugged into the same AC service.

Unbalanced Sources to EON Powered Loudspeakers

If you need to connect your EON speakers to an unbalanced source you have two options:

- Use the LINE 2 and LINE 3 connectors. These inputs are balanced but will accept unbalanced inputs without the need for any special adapters.
- Use an adapter or special cable (see Section 18 "Cables and Connectors")

Cables and Connectors

| | |
|--|--|
| XLR/F to XLR/M Microphone Cable | The standard cable for interconnection of microphone and line level signal in professional audio systems. <ul style="list-style-type: none"> • Microphone to mixer • Microphone to EON15 G2 INPUT 1 • Professional audio mixer to EON15 G2 INPUT 1 • "Daisy chaining" EON15 G2 speaker systems |
| TRS (Balanced) 1/4" Phone to XLR/M | For connecting balanced devices with 1/4" connector to EON XLR input. |
| TRS (Unbalanced) 1/4" Phone to XLR/M | For connection of instruments with unbalanced outputs to balanced XLR input. <ul style="list-style-type: none"> • Sources (signal processors, electronic instruments) with 1/4" unbalanced outputs to amps, processors, and powered speakers with balanced XLR/F inputs. |
| TS (Unbalanced) 1/4" Phone XLR/M | This cable is electrically identical to "TRS (unbalanced) 1/4" Phone to XLR/M above and may be used interchangeably. |
| XLR/M to RCA (phono) cable | Connects consumer audio products and some DJ mixer outputs to professional audio equipment inputs. |
| TS (Unbalanced) 1/4" Phone (phono) cable | <ul style="list-style-type: none"> • Connects outputs of consumer audio equipment to unbalanced line inputs of EON15 G2 and many mixers • Connects unbalanced line outputs to many mixers to the inputs of consumer audio recorder. |
| TRS 1/4" Phone to dual 1/4" Phone | Splits a stereo output into separate left/right signals. <ul style="list-style-type: none"> • Connects stereo electric guitar to two unbalanced audio inputs. • Connects a headphone output to two unbalanced audio inputs. • Change to a TRS mini-phone to connect to the output of portable CD players and computer sound cards to a mixer or powered speakers. Also used to connect signal processors to the "insert" of many mixing consoles. |
| XLR/F to XLR/M Audio Ground Lift | Used to "telescope" a ground to eliminate hum caused by "ground loops". For use only with balanced inputs and outputs. |

XLR/F to XLR/M Microphone Cable

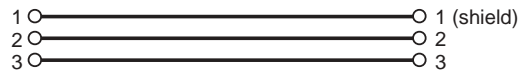

TRS (Balanced) 1/4" Phone to XLR/M Cable



TRS (Unbalanced) 1/4" Phone to XLR/M Cable



TS (Unbalanced) 1/4" Phone to XLR/M Cable



XLR/M to RCA (phono) Cable

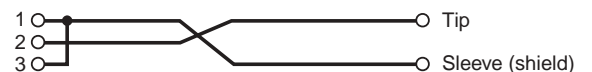

TS (Unbalanced) 1/4" Phone to RCA (phono) Cable

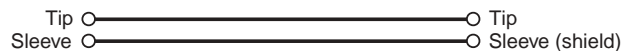

TRS 1/4" Phone to dual TS 1/4" Phone

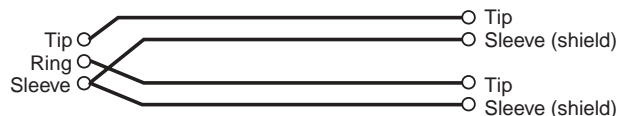

Loudspeaker Placement and Mounting

The following guidelines will help you achieve optimum sound wherever you use your EON loudspeakers:

Raise the speakers as high as possible. For best results try to get the high frequency horn at least 2 to 4 feet above the heads of the audience. If the speakers are too low, the people in the back of the audience will not receive the best quality sound.

Place the speakers between the microphones and the audience. Feedback occurs when the microphones pick up sound from the speakers and “feed” the sound back through the sound system. If space is limited, point the speakers away from the microphones to reduce feedback.

Locate the speakers away from turntables. Low-frequency feedback occurs when the output of the speaker is picked up by the tone arm of the turntable and is re-amplified. A heavy, solid turntable base and shock mounting can also reduce this type of feedback in DJ applications.

Use more speakers in large or highly reverberant spaces. Spreading speakers throughout these spaces will produce much better sound than trying to compensate with loudness level or equalization. For very long distances, the use of another set of speakers on a delay is recommended.

Stand speakers upright for PA - Tilt the speakers back for stage monitoring. Upright stance provides even coverage over a wide area. EON speakers are also designed with two slanted positions for stage monitoring applications.

BLOCK DIAGRAM

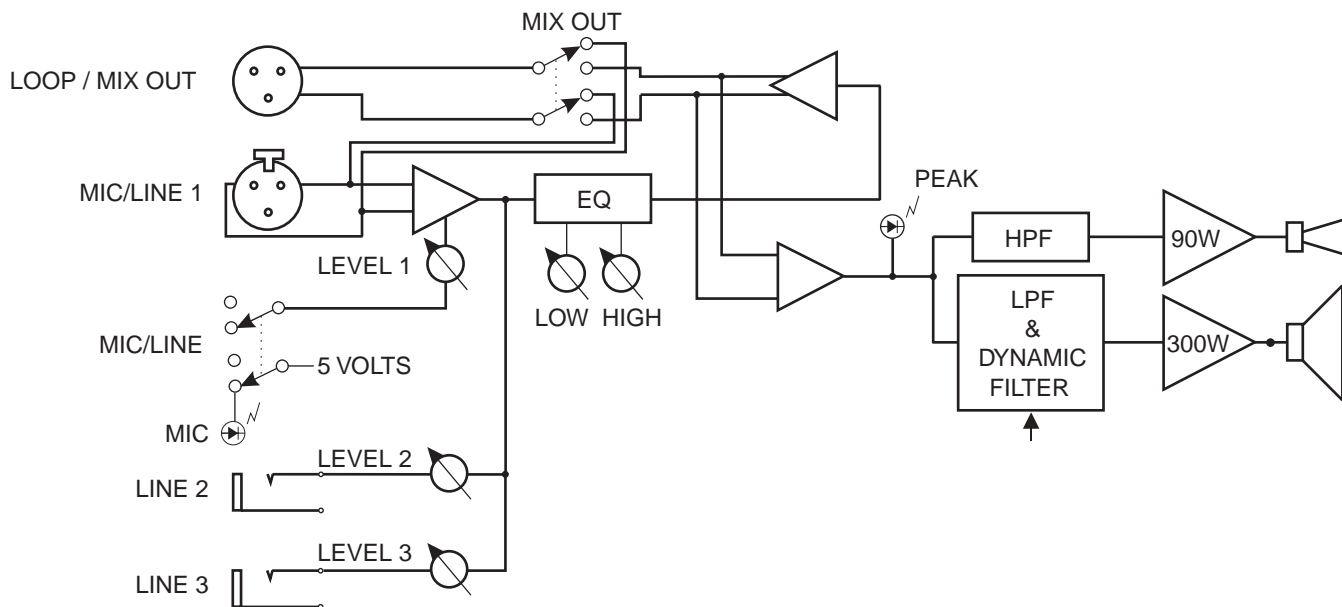

JBL WARRANTY AND CONTACTS

Who Is Protected by This Warranty?

Your JBL Warranty protects the original owner and all subsequent owners so long as: A.) Your JBL product has been purchased in the Continental United States, Hawaii or Alaska. (This Warranty does not apply to JBL products purchased elsewhere except for purchases by military outlets. Other purchasers should contact the local JBL distributor for warranty information.); and B.) The original dated bill of sale is presented whenever warranty service is required. The JBL Limited Warranty on professional loudspeaker products (except for enclosures) remains in effect for five years from the date of the first consumer purchase. JBL amplifiers are warranted for three years from the date of original purchase. Enclosures and all other JBL products are warranted for two years from the date of original purchase.

What does the JBL Warranty cover?

Except as specified below, your JBL Warranty covers all defects in material and workmanship. The following are not covered: Damage caused by accident, misuse, abuse, product modification or neglect; damage occurring during shipment; damage resulting from failure to follow instructions contained in your Instruction Manual; damage resulting from the performance of repairs by someone not authorized by JBL; claims based upon any misrepresentations by the seller; any JBL product on which the serial number has been defaced, modified or removed.

Who Pays for What?

JBL will pay all labor and material expenses for all repairs covered by this warranty. Please be sure to save the original shipping cartons because a charge will be made if replacement cartons are requested. Payment of shipping charges is discussed in the next section of this warranty.

How to Obtain Warranty Performance?

If your JBL product ever needs service, write or telephone us at JBL Incorporated (Attn: Customer Service Department), 8500 Balboa Boulevard, PO. Box 2200, Northridge, California 91329 (818/893-8411). We may direct you to an authorized JBL Service Agency or ask you to send your unit to the factory for repair. Either way, you'll need to present the original bill of sale to establish the date of purchase. Please do not ship your JBL product to the factory without prior authorization. If transportation of your JBL product presents any unusual difficulties, please advise us and we may make special arrangements with you. Otherwise, you are responsible for transporting your product for repair or arranging for its transportation and for payment of any initial shipping charges. However, we will pay the return shipping charges if repairs are covered by the warranty.

Contact Information

Mailing Address:

JBL Professional
8500 Balboa Blvd.
Northridge, CA 91329

Shipping Address:

JBL Professional
8370 Balboa Blvd., Dock D
Northridge, CA 91329

Customer Service:

Monday through Friday
8:00am - 5:00pm
Pacific Coast Time In the U.S.A.
(800) 8JBLPRO (800.852.5776)
www.jblproservice.com

On the World Wide Web:

www.jblpro.com

Outside the USA:

Contact the JBL Professional Distributor in your area. A complete list of JBL Professional international distributors is provided at our U.S.A. website - www.jblpro.com

Customer Registration:

Register online at www.jblpro.com/registration



H A Harman International Company